

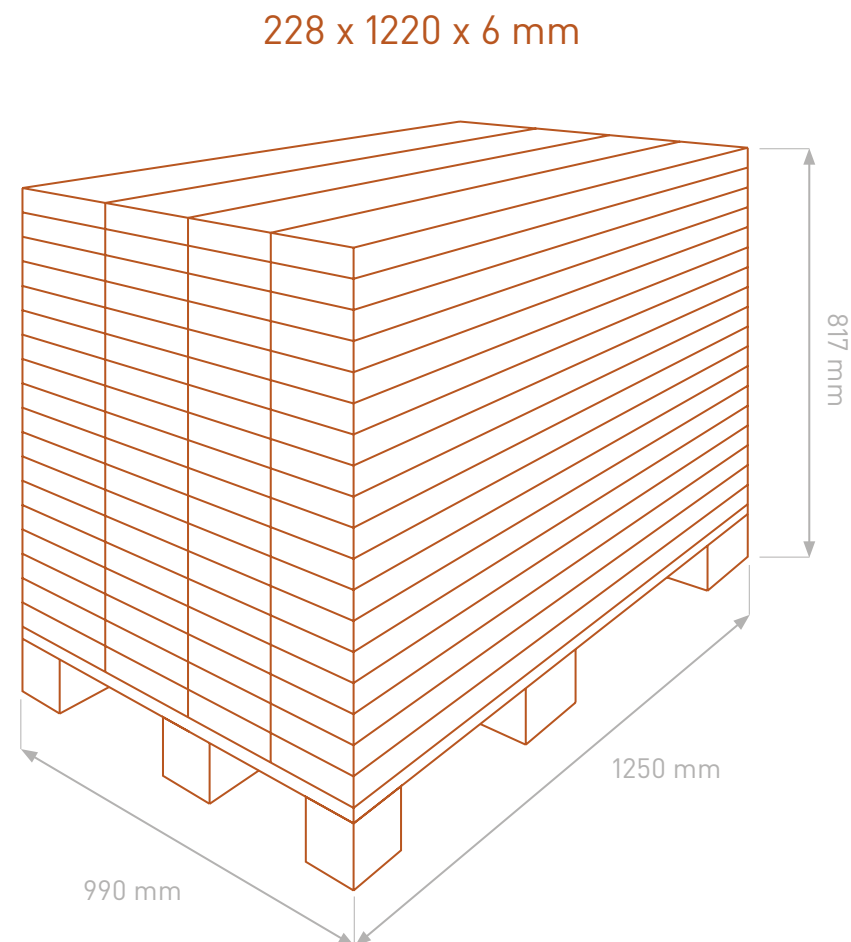







	LAMA HERRIGBONE	LAMA ESTÁNDAR
Medidas UNIQUE	750 x 150 x 6	1220 x 228 x 6
Lamas / Caja	14	7
m ² / Caja	1,575	1,947
Cajas / Palet	56	44
m ² / Palet	88,2	85,668
Kg / Caja	15,75	19,47



PRODUCTO	ETF CÓDIGO	EAN	M2 CAJA	LAMAS CAJA	CAJAS PALLET	TAMAÑO	CLICK	UNDERLAY	GROSOR
MAJESTIC OAK	SUNIQ830001	8436558845671	1,947	7	44	6 x 228 x 1220 mm	Uniclik	1 mm IXPE	6 mm
SAVANNAH	SUNIQ831001	8436558845688	1,947	7	44	6 x 228 x 1220 mm	Uniclik	1 mm IXPE	6 mm
ITALIAN OAK	SUNIQ832001	8436558845695	1,947	7	44	6 x 228 x 1220 mm	Uniclik	1 mm IXPE	6 mm
MYSTIC OAK	SUNIQ833001	8436558845701	1,947	7	44	6 x 228 x 1220 mm	Uniclik	1 mm IXPE	6 mm
DESERT OAK	SUNIQ834001	8436558845718	1,947	7	44	6 x 228 x 1220 mm	Uniclik	1 mm IXPE	6 mm
SAND OAK	SUNIQ835001	8436558845725	1,947	7	44	6 x 228 x 1220 mm	Uniclik	1 mm IXPE	6 mm
FLORIDA OAK	SUNIQ836001	8436558845732	1,947	7	44	6 x 228 x 1220 mm	Uniclik	1 mm IXPE	6 mm
CAIRO OAK	SUNIQ814001	8436558845749	1,947	7	44	6 x 228 x 1220 mm	Uniclik	1 mm IXPE	6 mm
SUTTON OAK	SUNIQ811001	8436558845756	1,947	7	44	6 x 228 x 1220 mm	Uniclik	1 mm IXPE	6 mm
CASTLE OAK	SUNIQ810001	8436558845763	1,947	7	44	6 x 228 x 1220 mm	Uniclik	1 mm IXPE	6 mm
TOASTED OAK	SUNIQ603001	8436558845770	1,947	7	44	6 x 228 x 1220 mm	Uniclik	1 mm IXPE	6 mm

CARACTERÍSTICAS		NORMATIVA	RESULTADO
	Sistema de click		UNILIN
	Medidas		228 x 1220 mm / 150 x 750 mm
	Grosor total		6 mm
	Backing		1 mm IXPE
	Capa de desgaste		0.55 mm
	Bisel		Bisel micro
	Clasificación EN429		33 / 42
	Grupo de desgaste EN649:2011		T
	Solidez de los colores a la luz EN ISO105 B02:2014		6
	Estabilidad dimensional ISO23999:2018	Dirección de fabricación. Dirección transversal de fabricación.	Dirección longitudinal 0,05 % Dirección transversal 0,015 %
	Deformación tras exposición al calor ISO23999:2018		0 mm
	Resistencia al deslizamiento DIN 51130:2014-02		R10
	Protección antiestática EN14041:2018/EN1815:2016		0.11 kv